



Network

Dome

QND-C8023R

5MP AI IR Dome Camera



Key Features

- Max. 5MP resolution
- Color: 0.05Lux(F1.6, 1/30sec), BW: 0.005Lux(F1.6, 1/30sec, 30IRE)
- Maximum 30fps@5MP (H.265/H.264)
- IR viewable length 30m (98.42ft)
- Day & Night (ICR), WDR (120dB), WiseNR II (Using AI engine)
- H.265, H.264, MJPEG, WiseStreamIII (Using AI engine)
- Dynamic Privacy Masking (Person/Vehicle)
- Analytics events based on AI engine (NPU) :
 - Object detection (Person/Vehicle - car, truck, bus, bicycle, motorcycle),
 - Color Attribute, BestShot
 - Motion detection, Virtual line(Crossing/Direction),
 - Virtual area(Loitering/Intrusion/Enter/Exit)
- Hard-coated dome bubble
- PoE: Max 8.1W

QND-C8023R

5MP AI IR Dome Camera



Specifications

Video

Imaging Device	Size	1/2.8"
	Type	CMOS
Resolution	2592x1944, 2560x1440, 1920x1080, 1280x960, 1280x720, 800x600, 800x448, 720x576, 720x480, 640x480, 640x360, 320x240	
Max. Framerate	H.265/H.264	30fps/25fps(60Hz/50Hz)
	MJPEG	30fps(@5MP Max. 5fps)
Min. Illumination (Lux)	Color(1/30sec, 30IRE)	0.05
	BW(1/30sec, 30IRE)	0.005
Video Out	USB: Micro USB Type B	

Lens

Focal Length (mm)	4.0	
Max Aperture Ratio (F number)	Wide	1.6
Angular Field of View	Horizontal	80°
	Vertical	59°
	Diagonal	102°
Min. Object Distance	0.5m(1.64ft)	
Focus Control	Fixed	
Lens Type	Fixed iris	
Mount Type	M12	

Pan / Tilt / Rotate

Pan / Tilt / Rotate Range	Pan	0°~355°
	Tilt	0°~75°
	Rotate	0°~355°

Operational

Day & Night	Auto(ICR)
Backlight Compensation	BLC, WDR, SDR
Wide Dynamic Range (dB)	120

Operational

Digital Noise Reduction		WiseNR II (Based on AI engine), SSNR V
Motion Detection	Quantity	8ea
	Shape	8point Polygonal zones
Privacy Masking	Quantity	32ea
	Shape	4point Quadrangle zones
	Color / Option	Gray, Green, Red, Blue, Black, White
Gain Control		Low, Middle, High
White Balance		ATW, AWC, Manual, Indoor, Outdoor
LDC		Support
Electronic Shutter	Mode	Minimum, Maximum, Anti flicker, Prefer shutter control(Based on AI engine)
	Speed Range	1/5~1/25,000sec
Digital PTZ		Support
Video Rotation		Flip, Mirror, Hallway view(90°/270°)
Alarm Interface	In/Out	Input 1ea, Output 1ea
	Others	Support alarm I/O through an optional cable
Alarm Triggers		Analytics, Network disconnect, Alarm input, MQTT subscription
Alarm Events When Alarm Trigger Occurred		File upload(image): e-mail/FTP/SFTP, Notification: e-mail, Recording: SD/SDHC/SDXC or NAS recording at event triggers, Alarm output, Handover: PTZ preset, send message by HTTP/HTTPS/TCP, Audio clip playback, MQTT: publication
Audio In		Built-in mic
Light Type		IR LED
Light Viewable Length	IR	30m(98.42ft)
IR Wavelength		850nm

Analytics

Classified Object Type		Person, Vehicle
Attributes	Person	Upper/Lower clothes color
	Vehicle	Type(car, bus, truck, motorcycle, bicycle), Color
Thumbnail		BestShot
Analytics Events	Based on AI Engine	Object detection, Virtual line(Crossing/Direction), Virtual area(Loitering/Intrusion/Enter/Exit), Motion detection
	Normal	Defocus detection, Tampering, Virtual area(Appear/Disappear)
Business Intelligence	Based on AI Engine	People counting, Queue management, Heatmap, Vehicle counting

Network

Ethernet		RJ-45(10/100BASE-T)
Video Compression		H.265/H.264: Main/High, MJPEG
Audio Compression		G.711 u-law /G.726 selectable, G.726(ADPCM) 8kHz, G.711 8kHz, G.726: 16kbps, 24kbps, 32kbps, 40kbps, AAC-LC: 48kbps at 16kHz

Network

Smart Codec		Manual, WiseStreamIII
Bitrate Control		H.265/H.264: CBR or VBR, MJPEG: VBR
Streaming	Unicast	Up to 20 users
	Multicast	Support
	Multiple Streaming	Up to 5 profiles
Protocol		IPv4, IPv6, TCP/IP, UDP/IP, RTP(UDP), RTP(TCP), RTCP, RTSP, NTP, HTTP, HTTPS, SSL/TLS, DHCP, FTP, SFTP, SMTP, ICMP, IGMP, SNMPv1/v2c/v3(MIB-2), ARP, DNS, DDNS, QoS, UPnP, Bonjour, LLDP, CDP, SRTP(TCP, UDP Unicast), MQTT
Application Programming Interface	ONVIF	S, G, T, M
	Others	SUNAPI(HTTP API), Hanwha Vision Open Platform
Direct Cloud Connection		Support

Security

OS / Firmware Protect	Encrypted firmware, Secure boot, Signed firmware	
User authentication	Digest authentication, Prevent brute-force attack	
Network authentication	IEEE 802.1X(EAP-TLS, EAP-LEAP, EAP-PEAP, MSCHAPv2)	
Secure Communication	HTTPS, WSS(WebSocket Secure)	
Access Control	IP-based access control	
Data Protect	Encryption credentials, Encrypt compress for live recording file export	
Audit	Access / System / Event Log management	
Device ID	Device certificate(Hanwha Vision Root CA)	
Secure Storage	SDcard partition encrypt(AES-256)	

General

Memory	RAM	2GB
	Flash	1GB
Edge Storage	Micro SD/SDHC/SDXC	Max. 256GB x 1slot

Environmental & Electrical

Operating Condition	Temperature	-10°C~+45°C(+14°F~+113°F)
	Humidity	0~95% RH(non-condensing)
Storage Condition	Temperature	-30°C~+60°C(-22°F~+140°F)
	Humidity	0~95% RH(non-condensing)
Input Voltage		PoE(IEEE802.3af, Class3)
Power Consumption	PoE	Max. 8.1W, typical 4.0W

Mechanical

Color	White	
Material	Plastic, Hard-coated dome	

Mechanical

RAL Code	RAL9003
Product Dimensions	ø110x90mm(ø4.33x3.54")
Product Weight	317g(0.70 lb)
Compatible Gang Box	Support compatibility via optional plate

Certifications & Standards

EMC	FCC 47 CFR 15 Subpart B Class A, ICES-3(A)/NMB-3(A), CE/UKCA - EN55032 Class A, EN 50130-4, EN 61000-3-2, EN 61000-3-3, VCCI CISPR 32 Class A, RCM AS-NZS CISPR 32 Class A, KS C 9832 Class A, KS C 9835
Safety	UL 62368-1, CAN/CSA C22.2 NO. 62368-1, IEC 62471
Environment	IEC/EN 63000

DORI (EN62676-4 standard)

Detect (25PPM/ 8PPF)	Wide	61.8m(202.7ft)
Observe (63PPM/ 19PPF)	Wide	24.7m(81.1ft)
Recognize (125PPM/ 38PPF)	Wide	12.4m(40.5ft)
Identify (250PPM/ 76PPF)	Wide	6.2m(20.3ft)

QND-C8023R

5MP AI IR Dome Camera



CAD

Unit: mm [inch]

QND-C8013R/C8023R INDOOR DOME CAMERA

Reference image

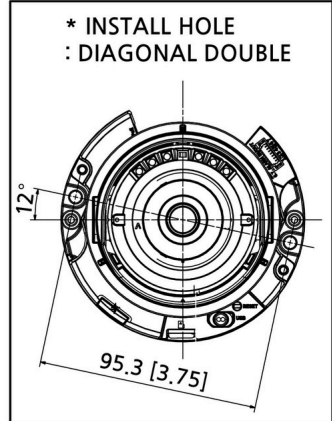
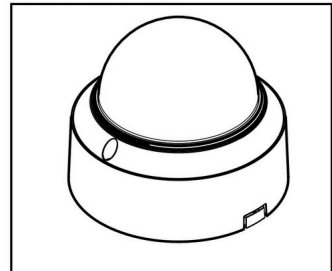
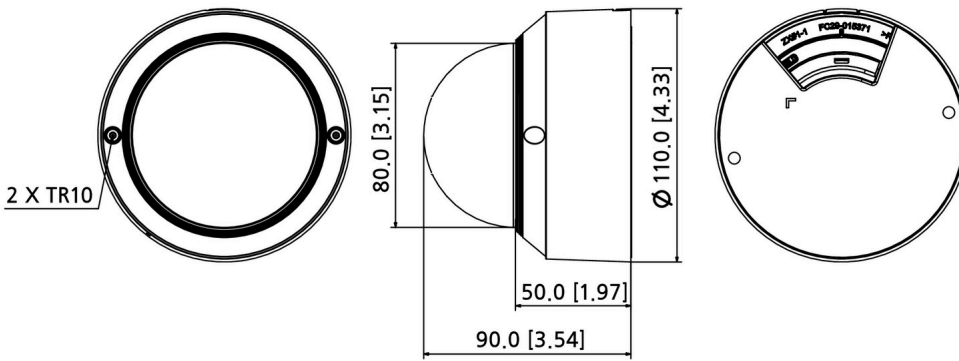

Revision	V1.0
Revision Date	24/12/20
Paper Size	A2
Unit	mm [inch]
Scale	1 : 1

© Hanwha Vision Co., Ltd. All right reserved.