

## DS-1268ZJ

Pendent Mounting Bracket for Dome Camera

### Features:

- Aluminum alloy material with surface spray treatment
- Design with cable entry hole

### Dimension:

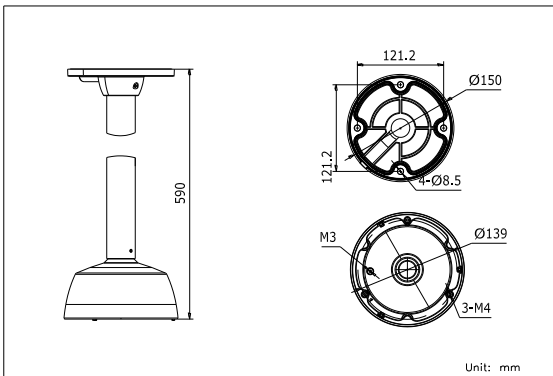

### Order Model:

DS-1268ZJ

### Parameter:

|                      |   |
|----------------------|---|
| Model                | DS-1268ZJ                                 |
| Parameters           | Pendent Mounting Bracket for Dome Camera  |
| Appearance           | Hikvision White                           |
| Range of Application | Suitable for dome camera pendent mounting |
| Material             | Aluminum Alloy                            |
| Dimension            | Φ 139 × 590mm                             |
| Weight               | 2200g                                     |



### Notice:

- The bracket is for dome camera
- Pay attention to color matching
- The bracket should be installed on flat wall
- The wall must be capable of supporting over 3 times as much as the total weight of the camera and the mount.
- The maximum load capacity of the bracket is 4.5KG

### Model Suitable:

DS-2CD72XXF-E(I)Z(H)(S), DS-2CD72X3PF-E(I)Z(H)(S), DS-2CD72X3NF-E(I)Z(H)(S), DS-2CD7293PFW-D-E(I)Z(H)(S), DS-2CD7293NFW-D-E(I)Z(H)(S), DS-2CD72X4FWD-E(I)Z(H)(S), DS-2CD4312F(WD)-(I)Z(H)(S), DS-2CD4324F-(I)Z(H)(S), DS-2CD4332FWD-(I)Z(H)(S)

### Installation Step:

① Choose the appropriate wall to fix base, pole and cap; complete wiring

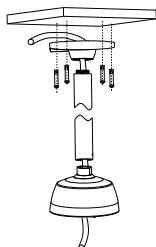

② Complete installation and screw up

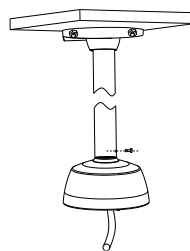

③ Take off lower dome and unscrew the zoom module

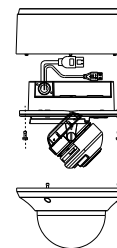

⑤ Wiring and fix zoom module to adaptor and adjust the angle of view

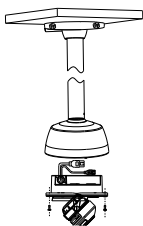

⑥ Unscrew the zoom module and fix the lower dome

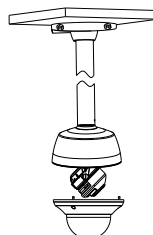

⑦ Installation Complete

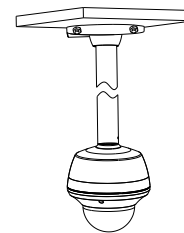

**Note:** The actual bracket may vary from the picture above.