

⊕ DIN rechts: S3 = Scharnier-Seite / S4 = Wand-Seite
 ⊕ DIN links: S3 = Wand-Seite / S4 = Scharnier-Seite
 ⊕ DIN rechts: S3 = côté charnière / S4 = côté-mur
 ⊕ DIN links: S3 = côté-mur / S4 = côté charnière
 ⊕ DIN rechts: S3 = scharnierzijde / S4 = zijwand
 ⊕ DIN links: S3 = zijwand / S4 = scharnierzijde
 ⊕ DIN rechts: S3 = lato cerniera / S4 = parete laterale
 ⊕ DIN links: S3 = parete laterale / S4 = lato cerniera
 ⊕ DIN rechts: S3 = hinge side / S4 = wall side
 ⊕ DIN links: S3 = wall side / S4 = hinge side

⊕ bündig - gleiche Höhe | ⊕ rincer - même hauteur bloqué | ⊕ spoelen - dezelfde hoogte | ⊕ flush - stessa altezza | ⊕ flush - same height

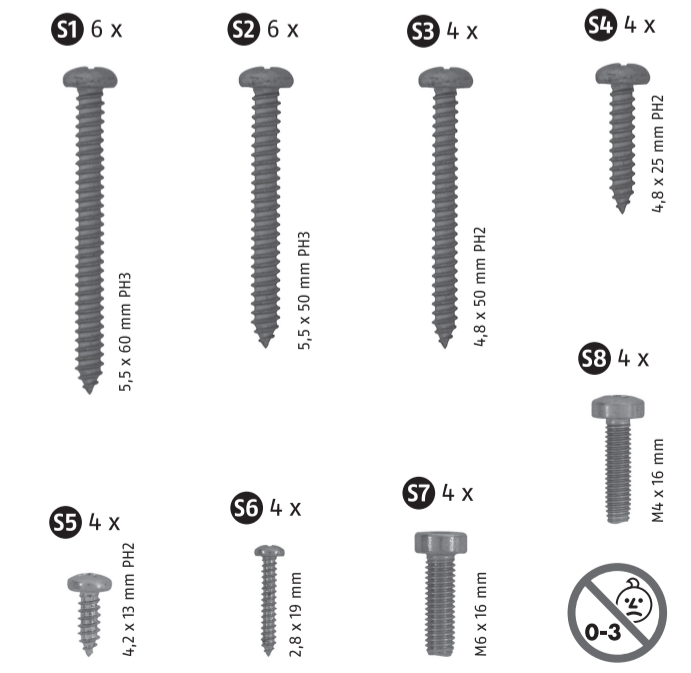
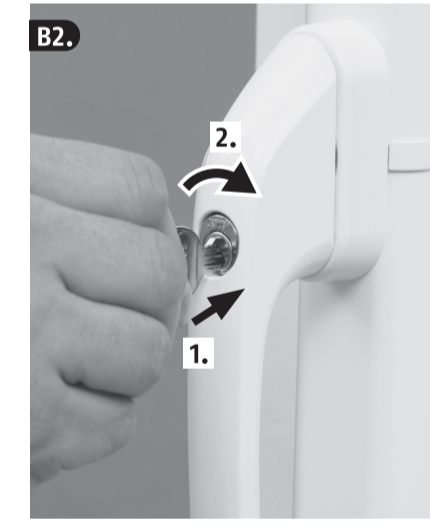
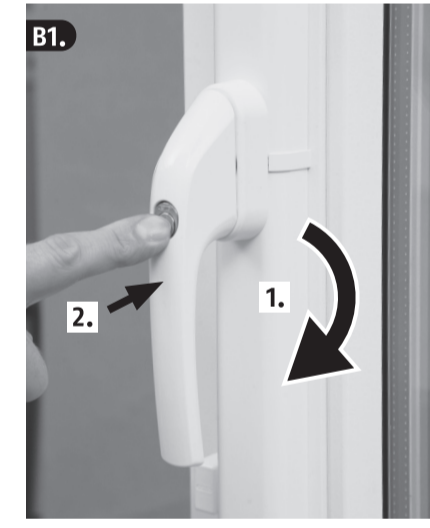
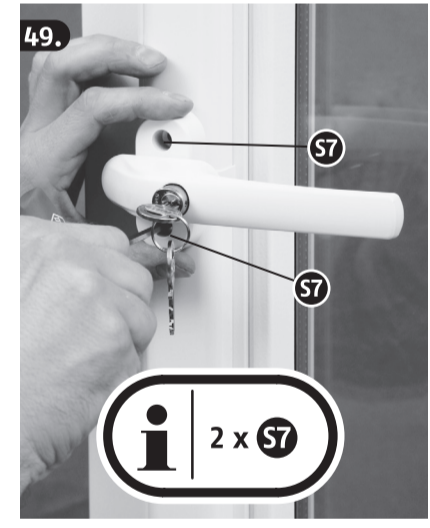
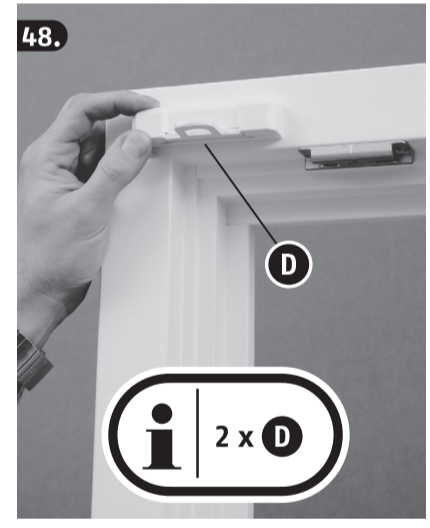
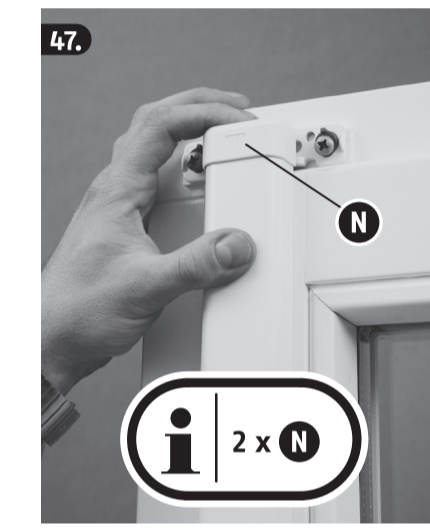
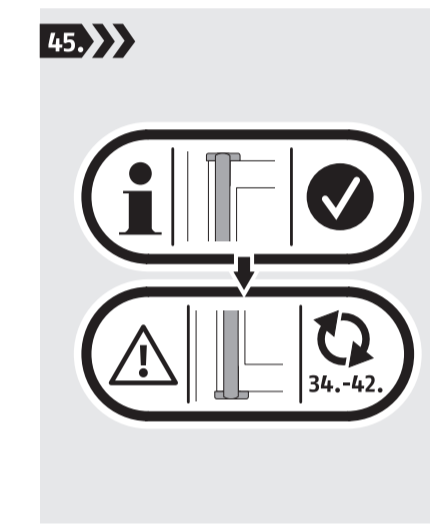
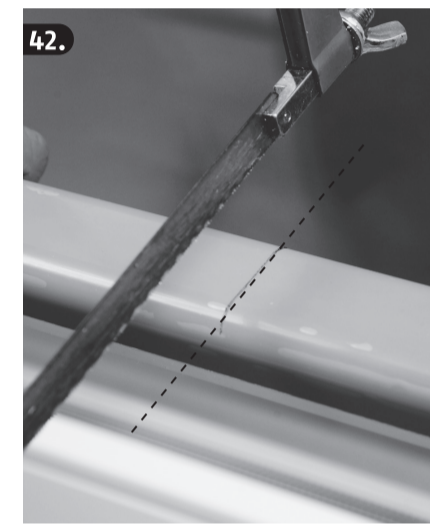
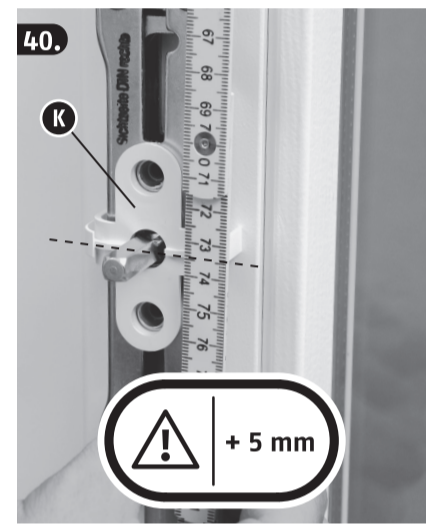
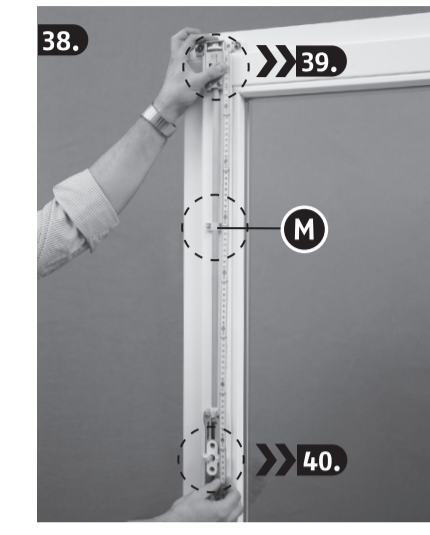
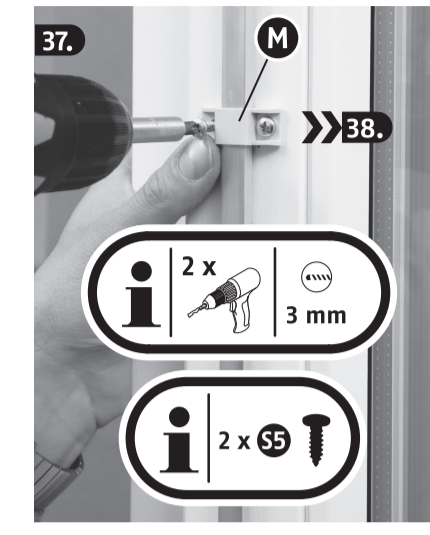
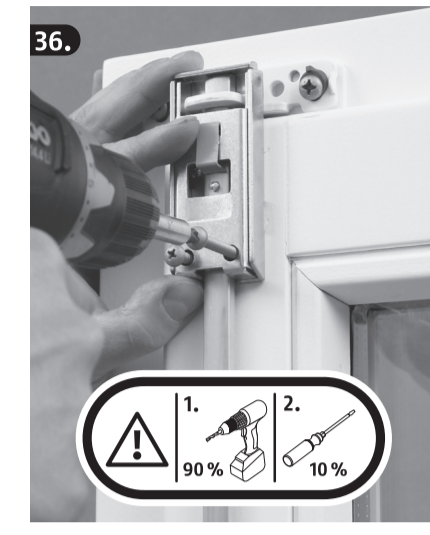
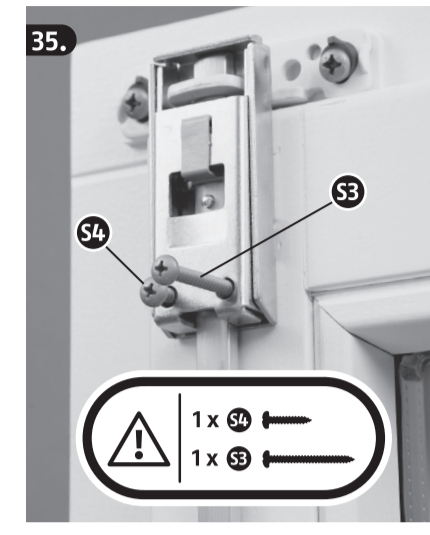
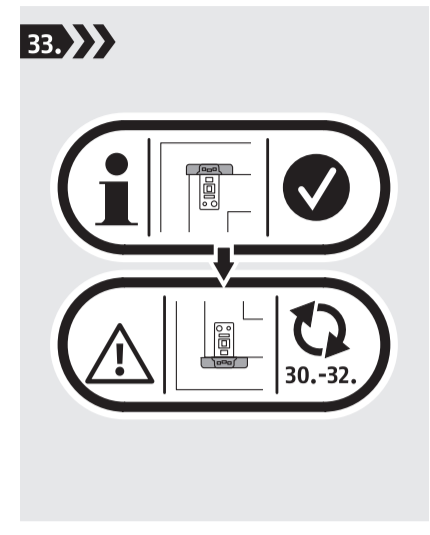
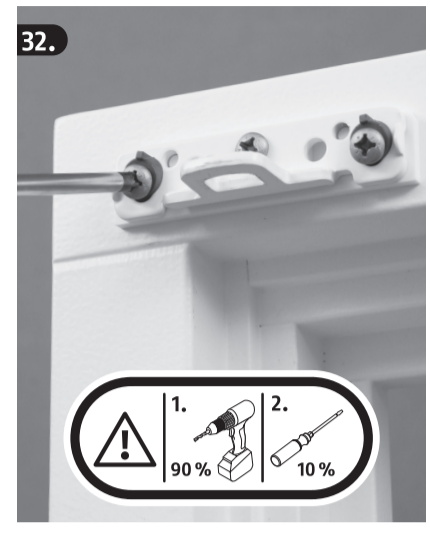
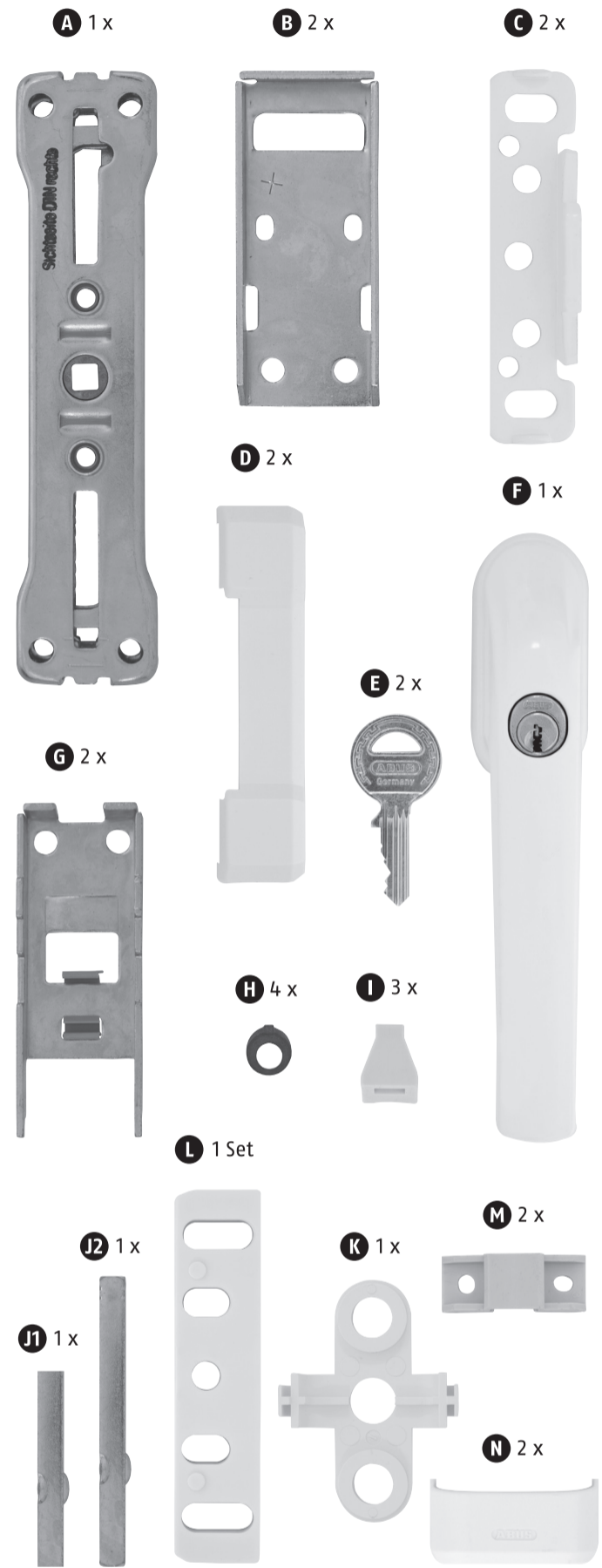

D Das Fenster-Stangenschloss FOS550 ist nach den strengen Prüfanforderungen der DIN 18104-1 und VdS 2536 anerkannt. Durch DIN Certo ist FOS550 zertifiziert "EINBRUCHHEMMEND DIN geprüft". FOS550 bietet zusätzlich Schutz gegen unberechtigtes Eindringen in Ihre Räume. Gemäß DIN 18104-1 wird empfohlen, dass pro 1 Meter Fensterhöhe rechts und links jeweils eine Zusatzsicherung montiert wird (pro Fenster). Bei der Montage der FOS550 braucht auf der Griffseite keine weitere Zusatzsicherung angebracht werden. Polizei und Versicherer empfehlen dieses ebenfalls. Die optimale Schutzwirkung erreichen Sie, wenn Sie entsprechend dieser Montage- und Bedienungsanleitung vorgehen. Die Befestigungsschrauben sollten zur Vermeidung von Überdrehung mit einem geeigneten Werkzeug eingeschraubt und von Hand angezogen werden. Anschließend ABUS-Befestigungsmaterial einsetzen. Für eventuell auftretende Verletzungen bzw. Schäden, die bei der Montage und/oder durch unsachgemäße Handhabung entstehen, übernimmt der Hersteller keine Haftung! Ein Zugang des gesamten Objektes muss von außen mittels Schlüssel zu öffnen sein. Bei schlechten Befestigungsmöglichkeiten sollten zusätzliche Befestigungsmittel eingesetzt werden. Hierzu verwenden Sie bitte den ABUS Befestigungsanker BA oder alternativ das ABUS-Befestigungsset IM100. Zu IM100 benötigen Sie einen geeigneten handelsüblichen Verbundmörtel. ABUS BA und ABUS IM100 sowie Verklebmittel sind im Handel erhältlich. Als Sonderzubehör ist ein Set mit Bodenhülse BS850 und ein Set für Doppelflügel Fenster DS850 im Handel erhältlich.

Auswahl der Riegelstangen: Gemessen wird der Fenster- oder Fensterstürrüffel von der Mitte des vorhandenen Griffverkanals nach oben bzw. nach unten. (Tab. 1)

Technische Änderungen vorbehalten.
Für Irrtümer und Druckfehler keine Haftung.

FR La tringle de verrouillage pour fenêtre répond aux exigences de contrôle strictes des normes DIN 18104-1 et VdS 2536. Le FOS550 est certifié «RETARDATEUR D'EFFRACTION» par DIN Certo. Le FOS550 offre une protection supplémentaire contre les intrusions non autorisées dans vos locaux. Conformément à la norme DIN 18104-1, il est recommandé d'installer une sécurité supplémentaire à droite et à gauche tous les 1 mètre de hauteur de fenêtre (par fenêtre). En cas de montage du FOS550, il n'est pas nécessaire d'installer une sécurité supplémentaire du côté de la poignée. Cela correspond également aux recommandations de la police et des assurances. Le niveau de protection maximale ne peut être atteint que si la présente notice de montage et d'utilisation est suivie point par point. Afin d'éviter de forcer les filetages, il est fortement conseillé de serrer les vis avec un outil approprié ou à la main. Utilisez exclusivement les éléments de fixation fournis par ABUS. Le fabricant décline toute responsabilité concernant les éventuels blessures ou dommages qui pourraient survenir lors du montage et/ou par la mauvaise utilisation! L'accès aux locaux doit être possible de l'extérieur au moyen d'une clé. En cas de mauvaises conditions de fixation des moyens de fixation complémentaires (ancrage de fixation ou mortier chimique) doivent être prévus. Pour cela, utilisez l'ancrage de fixation ABUS BA ou alternativement le kit de fixation ABUS IM100. Pour le kit IM100, un mortier chimique approprié est requis. Les ABUS BA et ABUS IM100 ainsi que le mortier chimique sont disponibles dans le commerce. Un jeu de douilles de fond BS850 et un kit pour fenêtres à double vantail DS850 sont également disponibles dans le commerce.

Choix des tringles de verrouillage: Il faut mesurer le vantail de la fenêtre ou de la portefenêtre à partir du centre de la goupille carrée de la poignée existante vers le haut ou vers le bas. (Tab. 1)

Nous nous réservons le droit de toutes modifications techniques. Nous n'assumons aucune responsabilité por des erreurs ou défauts d'impression éventuels.

NL De vergrendelingsbalk voor ramen FOS550 is aan strenge testen van het DIN 18104-1 en VdS 2536 onderworpen. Volgens het DIN certificaat is de FOS550 „DIN INBRAAKWEREND bevonden“. FOS550 biedt extra beveiliging tegen het onbevoegd betreden van uw ruimte. In DIN 18104-1 wordt aangeraden om per 1 meter raamhoogte respectievelijk links en rechts een extra beveiliging te monteren (per raam). Bij de montage van de FOS550 hoeft bij de sluitzijde geen extra beveiliging aangebracht te worden. De politie en verzekeringmaatschappijen raden dit echter wel aan. De optimale beveiliging bereikt u, wanneer u deze montage- en gebruikershandleiding volgt. Om te voorkomen dat de bevestigingschroeven lam draaien, dienen deze met geschikt gereedschap bevestigd te worden en met de hand aangedraaid. Gebruik uitsluitend ABUS-bevestigingsmateriaal. Voor eventueel letsel of schade veroorzaakt tijdens de installatie en/of door ondeskundig gebruik, neemt de fabrikant geen verantwoordelijkheid! Het gehele object moet van buitenaf met een sleutel kunnen worden geopend. Bij slechte montageomstandigheden dienen er aanvullende bevestigingsmiddelen gebruikt te worden (bevestigingsbouten of verbindingsmortel). Gebruik hier a.u.b. het ABUS BA bevestigingsanker voor of als alternatief de ABUS bevestigingsset IM100. Voor de IM100 hebt u geschikte verbindingsmortel nodig. De ABUS BA en de ABUS IM100, alsmede de verbindingsmortel zijn apart verkrijgbaar. Als speciaal accessoire is een set bodembescherming BS850 en een set voor dubbele openstaande ramen DS850 beschikbaar.

Keuzemogelijkheid bouten: Het draaigedeelte van het raam of glasdeur wordt naar boven of beneden gemeten vanuit het midden van de beschikbare kruk. (Tab. 1)

Technische wijzigingen voorbehouden. Geen aansprakelijkheid voor vergissingen en drukfouten.

IT La serratura a barra per finestra FOS550 è conforme ai più rigorosi requisiti di controllo della DIN 18104-1 e della Vds 2536. Con la DIN Certo, FOS550 è certificata come «ANTI-CASSO DIN». FOS550 fornisce protezione maggiore da accessi non autorizzati alla vostra casa. In linea con il DIN 18104-1, si consiglia di montare per ogni metro di altezza della finestra una sicura supplementare sul lato destro e sul lato sinistro (per ogni finestra). Quando si monta FOS550, non è necessario applicare al lato maniglia nessuna sicura supplementare. Anche la polizia e le compagnie di assicurazione consigliano questi adeguamenti alla sicurezza. Una ottimale condizione di sicurezza sarà ottenuta se saranno rispettate le presenti istruzioni per il montaggio e il funzionamento. Le viti di fissaggio devono essere avvitare con un utensile adatto per evitare un serraggio eccessivo e poi serrate a mano. Utilizzare esclusivamente materiali di fissaggio ABUS. Il produttore non si assume alcuna responsabilità per lesioni o danni causati durante l'installazione e/o per uso improprio! Deve essere possibile accedere a tutta l'unità dall'esterno tramite chiave. In caso di non ottimali possibilità di fissaggio (finestre in legno tenero o in plastica) deve essere utilizzato un dispositivo di fissaggio aggiuntivo (bullone di fissaggio o malta di sintesi). A questo scopo, vi invitiamo ad utilizzare il bullone di fissaggio ABUS BA (finestre in plastica e in legno tenero) o, in alternativa, il set di fissaggio ABUS IM100 (finestre in plastica). Per l'IM100 serve una malta di sintesi adatta presente sul mercato. ABUS BA, ABUS IM100 e la malta di sintesi si possono trovare facilmente in commercio. È disponibile in commercio, come accessorio speciale, un set di manicotti da suolo BS850 e un set per finestra a doppio battente DS850.

Scelta delle barre dei chiovi: Il battente della finestra / portafinestra viene misurato dal centro del quadrato della maniglia esistente, verso l'alto o verso il basso. (Tab. 1)

Ci si riservano modifiche tecniche. Per errori e redflussi di stampa non ci si assume alcuna responsabilità.

GB The FOS550 deadbolt window lock has been acknowledged to have satisfied the rigorous testing demands of DIN 18104-1 and Vds 2536. FOS550 has been certified in Germany by DIN Certo as being "Burglary-resistant according to DIN". FOS550 offers additional protection from unauthorised entry into your premises. In accordance with DIN 18104-1 you are recommended to install one extra security fitting to the left and the right per metre of window height (per window). The installation of the FOS550 does not require the fitting of any additional locks on the handle side. The same recommendations are made by the police and insurance companies. You will achieve the best possible protective effect if you proceed according to these installation and operating instructions. To avoid the risk of over-tightening, the fixing screws should be screwed in using a suitable tool and tightened manually. You should use only ABUS fixing materials. The manufacturer will not be liable for any injuries or damage that may occur in the course of installation and/or improper operation! It must be possible to gain access to the whole building from outside using a key. In poor fixing conditions additional fastenings should be used (composite mortar or fixing bolts). For this purpose please use the ABUS BA fixing bolt or, alternatively, the ABUS IM100 fixing set. For IM100 you need a suitable composite mortar, available from all DIY outlets. ABUS BA and ABUS IM100 are available from retail outlets along with composite mortar. A BS850 floor striking plate set and DS850 striking plate set for double casement windows are available to buy as special accessories.

Choice of locking bars: The measurement of the window or French door casement is taken from the middle of the existing handle square in an upwards or downwards direction. (Tab. 1)

Subject to technical alterations. No liability for mistakes and printing errors.

Stangenset	Stangenlänge	Nutzhöhe
Jeu de barres	Longueurs de barres	Hauteur effective
Rod set	Lengthe staaft	Effectieve hoogte
Set rod	Lunghezza asta	Altezza effettiva
Bar set	Length of bars	Usable height
1	75/75 cm	80/80 cm
2	75/118 cm	80/123 cm
3	118/118 cm	123/123 cm
4	150/150 cm	155/155 cm

(Tab. 1)

	90%	10%

0-3 Achtung! Kleinteile können von Kindern verschluckt werden! Attention! Les petites pièces peuvent être avalées par les enfants! Let op! Kleine onderdelen kunnen door kinderen worden ingeslikt! Attenzione! Piccole parti possono essere ingerite dai bambini! Attention! Children can swallow small parts!

! Mögliche Sachschäden
Dégâts matériels possibles
Mogelijk materiële schade
Possibili danni materiali
Potential damage to property

i Hinweise zur Montage
Instructions de montage
Instructies voor de montage
Note per l'installazione
Further fitting details

? *ABUS August Bremicker Söhne KG
Altenhofer Weg 25
D 58300 Wetter
Tel.: +49 23 35 63 40
www.abus.com

FR ABUS France SAS
www.abus.fr